

ЦЕНОВНИК ЗА ИНДУСТРИСКИ ИНСТАЛАЦИИ

BEZRABNA CEVKA OD ^ELI K

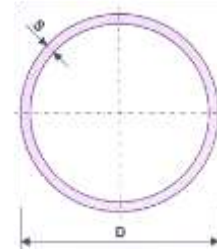

STANDARD: DIN 2448 / 1629
MATERIЈAL: ST.37 - ^.1212 / ST.35.8 - ^.1214
POTEKLO: ^E[KA, ROMANI JA
DOL@I NA: 5 mtr - 7 mtr
LEGENDA:
S - DEBELI NA NA YI DOT
D - NADVORE[EN DI JAMETAR



D, mm	S, mm	kg / mtr	cena / mtr so DDV	cena / kgr so DDV
10,2	1,6	0.339		
13,5	2,0	0.567		
	2,6	0.699		
17,2	2,3	0.845		
	2,9	1.02		
21,3	2,3	1.08		
	2,6	1.20	266	222
	2,9	1.32		
26,9	2,3	1.40	484	346
	2,6	1.56	254	163
	2,9	1.72	260	151
33,7	2,6	1.99	296	149
	2,9	2.20		
	3,2	2.41	368	153
38,0	2,6	2.27		
	2,9	2.51		
	3,0		309	
	3,6	3.05		
42,4	2,6	2.55	384	151
	2,9	2.82		
	3,2	3.09	476	154
48,3	2,6	2.93	466	159
	2,9	3.25		
	3,2	3.56	510	143
51,0	2,6	3.10		
	2,9	3.44		
	4,0	4.64		
57,0	2,9	3.87		
	3,2	4.25		
	3,6	4.74		
60,3	2,9	4.11	695	169
	3,2	4.51	762	169
	3,6	5.03		
63,5	2,9	4.33		
	3,6	5.32		
	4,0	5.87		
70,0	2,9	4.80		
	3,2	5.27		
	3,6	5.90		
76,1	2,9	5.24	914	174
	3,2	5.75		
	3,6	6.44	980	152
	4,5			

D, mm	S, mm	kg / mtr	cena / mtr so DDV	cena / kgr so DDV
88,9	3,2	6.76	1050	155
	3,6	7.57	1475	195
	4,0	8.38		
101,6	3,6	8.70		
	4,0	9.63		
	5,0	11.90		
108,0	3,6	9.27	1496	161
	4,0	10.30		
	4,5	11.50		
114,3	3,6	9.80	1711	175
	4,0	10.90		
	4,5	12.20		
133,0	4,0	12.70	2444	192
	5,0	15.80		
	6,3	19.70		
	8,0			
159,0	4,5	17.10	2510	147
	5,0			
	5,6	21.20		
	6,3	23.70		
168,3	4,5	18.2	3592	142
219,1	6,3	33.1	7733	234
	7,1	37.10		
	10,0	51.60		
273,0	6,3		7892	
	7,1	46.60		
	8,0	52.30	8612	165
323,9	7,1	55.50		
	8,0	62.30		
355,6	8,0	68.60		
406,4	11,0	107.00		

ZABELE[KA:
PO NARA^KA NUDI ME I
VI SOKOPRECI ZNI CEVKI

STANDARD: ANSI B.36.10
MATERI JAL: API 5L, A 106
POTEKLO: ^E[KA, ROMANI JA
DOL@I NA: 5 mtr - 7 mtr

LEGENDA:

S - DEBELI NA NA YI DOT
D - NADVORE[EN DI JAMETAR
ND - NOMI NALEN DI JAMETAR

D, mm	DEBELI NA SCH STD				cena / mtr со ддв	DEBELI NA SCH XS			
	ND, inch	S, mm	kg / mtr	kg / mtr		ND, inch	S, mm	kg / mtr	kg / mtr
21.3	1/2"	2.8	1.27	179	1/2"	3.7	1.62		
26.7	3/4"	2.9	1.68	200	3/4"	3.9	2.19		
33.4	1"	3.4	2.50	267	1"	4.6	3.23		
42.2	5/4"	3.6	3.38	385	5/4"	4.9	4.47		
48.3	6/4"	3.7	4.05	1241	6/4"	5.1	5.41		
60.3	2"	3.9	5.44	1495	2"	5.5	7.48		
73.0	2 1/2"	5.2	8.62		2 1/2"	7.0	11.40		
88.9	3"	5.5	11.30	1266	3"	7.6	15.30		
114.3	4"	6.0	16.10	1835	4"	8.6	22.30		
141.3	5"	6.6	21.80		5"	9.5	31.00		
168.3	6"	7.1	28.30		6"	11.0	42.60		
219.1	8"	8.2	42.60		8"	12.7	64.60		
273.0	10"	9.3	60.30		10"	12.7	81.60		
323.8	12"	9.5	73.90		12"	12.7	97.50		
355.6	14"	9.5	81.30		14"	12.7	107.00		

D, mm	DEBELI NA SCH 20				cena / mtr со ддв	DEBELI NA SCH 30			
	ND, inch	S, mm	kg / mtr	kg / mtr		ND, inch	S, mm	kg / mtr	kg / mtr
219.1	8"	6.4	33.30		8"	7.0	36.80		
273.0	10"	6.4	41.80		10"	7.8	51.00		
323.8	12"	6.4	49.70		12"	8.4	65.20		

D, mm	DEBELI NA SCH 40			
	ND, inch	S, mm	kg / mtr	cena / mtr со ддв
323.8	12"	10.3	79.70	
355.6	14"	11.1	94.50	

БЕЗРАБНИ ЦРНИ КОЛЕНА

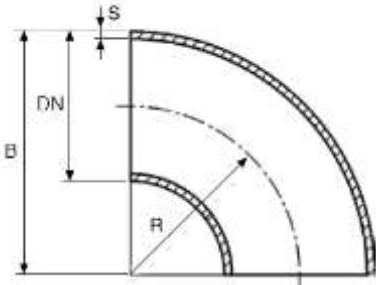

RACCORDERIE METALLICHE

Арт. 704

Безшавни челични колена 90°

Стандарт: EN 10253-1 (DIN 2605)

Материјал: P235TR1 - S235 (R.St.37.0)

DN	S				Без ДДВ	Со ДДВ
мм	мм				ден/пар	ден/пар
17,2	2				220	260
21,3	2				112	132
26,9	2,3				112	132
33,7	2,6				97	115
42,4	2,6				108	128
48,3	2,6				136	160
57	2,9				306	361
60,3	2,9				220	260
70	2,9				378	446
76,1	2,9				352	415
88,9	3,2				540	637
101,6	3,6				724	854
108	3,6				894	1055
114,3	3,6				980	1156
133	4				1615	1906
139,7	4				1642	1938
159	4,5				2521	2975
168,3	4,5				2657	3135
193,7	5,6				5063	5974
219,1	6,3				6782	8003
244,5	6,3				13593	16040
273	6,3				14517	17130
323,9	7,1				21764	25682

БЕЗРАБНИ ЦРНИ КОНЦЕНТРИЧНИ РЕДУЦИРИ

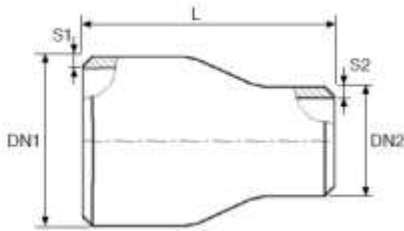

Арт. 276
Безрабни челични концентрични редуцири
Стандард: DIN 2616 серија 3

DN1	DN2	S1	S2	L	Без ДДВ	Со ДДВ
мм	мм	мм	мм	мм	ден/пар	ден/пар
33,7	26,9	2,6	2,3	50	243	287
42,4	26,9	2,6	2,3	50	264	312
42,4	33,7	2,6	2,6	50	241	284
48,3	26,9	2,6	2,3	64	355	419
48,3	33,7	2,6	2,6	64	291	343
48,3	42,4	2,6	2,6	64	250	295
60,3	33,7	2,9	2,6	76	368	434
60,3	42,4	2,9	2,6	76	319	376
60,3	48,3	2,9	2,6	76	280	330
76,1	42,4	2,9	2,6	90	433	511
76,1	48,3	2,9	2,6	90	382	451
76,1	60,3	2,9	2,9	90	349	412
88,9	42,4	3,2	2,6	90	905	1068
88,9	48,3	3,2	2,6	90	638	753
88,9	60,3	3,2	2,9	90	502	592
88,9	76,1	3,2	2,9	90	415	490
101,6	60,3	3,6	2,9	100	1174	1385
101,6	76,1	3,6	2,9	100	796	939
101,6	88,9	3,6	3,2	100	723	853
108	60,3	3,6	2,9	100	1140	1345
108	76,1	3,6	2,9	100	866	1022
108	88,9	3,6	3,2	100	724	854
114,3	60,3	3,6	2,9	100	1168	1378
114,3	76,1	3,6	2,9	100	906	1069
114,3	88,9	3,6	3,2	100	790	932
114,3	101,6	3,6	3,6	100	757	893
133	76,1	4	2,9	127	2094	2471
133	88,9	4	3,2	127	1534	1810
133	101,6	4	3,6	127	1927	2274
133	108	4	3,6	127	1372	1619

DN1	DN2	S1	S2	L	Без ДДВ	Со ДДВ
мм	мм	мм	мм	мм	ден/пар	ден/пар
133	114,3	4	3,6	127	1366	1612
139,7	76,1	4	2,9	127	2148	2535
139,7	88,9	4	3,2	127	1827	2156
139,7	101,6	4	3,6	127	1775	2095
139,7	108	4	3,6	127	1536	1812
139,7	114,3	4	3,6	127	1376	1624
139,7	133	4	4	127	1304	1539
159	88,9	4,5	3,2	140	3067	3619
159	101,6	4,5	3,6	140	2524	2978
159	108	4,5	3,6	140	2172	2563
159	114,3	4,5	3,6	140	1958	2310
159	133	4,5	4	140	1649	1946
159	139,7	4,5	4	140	1651	1948
168,3	88,9	4,5	3,2	140	3099	3657
168,3	101,6	4,5	3,6	140	2762	3259
168,3	108	4,5	3,6	140	2540	2997
168,3	114,3	4,5	3,6	140	2030	2395
168,3	133	4,5	4	140	1746	2060
168,3	139,7	4,5	4	140	1757	2073
168,3	159	4,5	4,5	140	1770	2089
219,1	114,3	6,3	3,6	152	5050	5959
219,1	133	6,3	4	152	3901	4603
219,1	139,7	6,3	4	152	3322	3920
219,1	159	6,3	4,5	152	3201	3777
219,1	168,3	6,3	4,5	153	3233	3815
273	159	6,3	4	178	7749	9144
273	168,3	6,3	4,5	178	6249	7374
273	219,1	6,3	6,3	178	5316	6273
323,9	219,1	7,1	6,3	178	11178	13190
323,9	273	7,1	6,3	178	10031	11837

*цените се во денари
*го задржуваме правото на измени без обврска кон клиентите

11.04.2022

ФИТИНГ ЗА ЗАВАРУВАЊЕ ПО ANSI B.16.9 STD
МАТЕРИЈАЛ: ASTM A234 СЕРТИФИКАТ: DIN 50049/3.1.B

ND, inch	KONCEN. REDUCI R		EKSCENT. REDUCI R	TE[TI K REDUCI R	ND, inch	KONCEN. REDUCI R		EKSCENT. REDUCI R	TE[TI K REDUCI R
	92	109				1272	1501		
3/4 X 1/2	92	109			4 X 11/2				
1 X 1/2	134	158			4 X 2	1272	1501		
1 X 3/4	124	146			4 X 2 1/2	1063	1254		
1 1/4 X 1/2	113	133			4 X 3	871	1028		
1 1/4 X 3/4	158	187			4 X 3 1/2				
1 1/4 X 1	157	185			5 X 2	1389	1639		
1 1/2 X 1/2					5 X 2 1/2	1414	1668		
1 1/2 X 3/4	218	257			5 X 3	1472	1737		
1 1/2 X 1					5 X 3 1/2	1045	1233		
1 1/2 X 1 1/4	163	192			5 X 4	1093	1290		
2 X 1/2					6 X 2				
2 X 3/4	329	388			6 X 2 1/2	1898	2240		
2 X 1	351	414			6 X 3	1841	2172		
2 X 1 1/4	263	310			6 X 3 1/2				
2 X 1 1/2	237	280			6 X 4	1754	2070		
2 1/2 X 1	423	499			6 X 5	1682	1985		
2 1/2 X 1 1/4	451	532			8 X 3				
2 1/2 X 1 1/2	443	523			8 X 4				
2 1/2 X 2	375	442			8 X 5				
3 X 1					8 X 6				
3 X 1 1/4	781	922			10 X 4				
3 X 1 1/2	677	799			10 X 5				
3 X 2	519	612			10 X 6	4490	5298		
3 X 2 1/2	507	598			10 X 8	4999	5899		
3 1/2 X 1 1/2					12 X 6				
3 1/2 X 2					12 X 8				
3 1/2 X 2 1/2					12 X 10				
3 1/2 X 3					14 X 10				

PROI ZVODI TEL: RACORDERIE METALLICHE SPA, I TALI JA
UVOZNI K: METALTERM DOO, SKOPJE, MAKEDONI JA

БЕЗРАБЕН ФИТИНГ ЗА ЗАВАРУВАЊЕ



ФИТИНГ ЗА ЗАВАРУВАЊЕ ПО **ANSI B.16.9 STD**
 МАТЕРИЈАЛ: **ASTM A234** СЕРТИФИКАТ: **DIN 50049/3.1.B**
 ЦЕНА денари без и со DDV, PAR^E



ND, inch	NADVORE [EN DI JAMETAR	DEBELI NA NA YI DOT	KOLENO		TE [TI K		KAPA	
			без DDV	со ДДВ	без DDV	со ДДВ	без DDV	со ДДВ
1/2"	21,34	2,77	64	75	181	213		
3/4"	26,67	2,87	78	92	197	233		
1"	33,40	3,38	109	129	304	359		
1 1/4"	42,16	3,56	149	176	437	516	136	161
1 1/2"	48,26	3,68	211	249	490	578		
2"	60,33	3,91	270	319	545	643	179	211
2 1/2"	73,03	5,16	506	597	887	1047	264	312
3"	88,90	5,49	932	1100	1572	1855	353	416
3 1/2"	101,60	5,74						
4"	114,30	6,02	1753	2068	2411	2845	551	650
5"	141,30	6,55	2858	3372	2537	2994	722	852
6"	168,28	7,11	4203	4960	5042	5950	1068	1260
8"	219,08	8,18	5986	7064			3203	3780
10"	273,05	9,27						
12"	323,85	9,53						

PROI ZVODI TEL: **RACORDERIE METALLICHE SPA**, I TALI JA
 UVOZNI K: **METALTERM DOO**, SKOPJE, MAKEDONI JA

*цените се во денари
 *го задржуваме правото на измени без обврска кон клиентите

01.04.2025

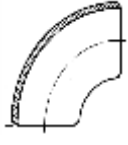
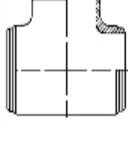
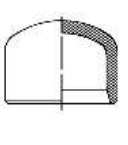
**FI TI NG ZA ZAVARUVAVE PO ANSI B.16.9 XS
MATERI JAL: ASTM A234 SERTI FI KAT: DIN 50049/3.1.B
PO BARAVE**

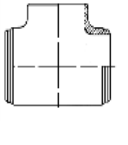
ND, inch	DEBELI NA NA YI DOT				ND, inch			
1/2"	3,73				3/4 X 1/2			
3/4"	3,91				1 X 1/2			
1"	4,55				1X3/4			
1 1/4"	4,85				1 1/4 X 1/2			
1 1/2"	5,08				1 1/4X3/4			
2"	5,54				1 1/4 X 1			
2 1/2"	7,01				1 1/2 X 1			
3"	7,62				1 1/2X1 1/4			
3 1/2"	8,08				2 X 1			
4"	8,56				2X1 1/4			
5"	9,53				2 X 1 1/2			
6"	10,97				2 1/2 X 1 1/2			
8"	12,70				2 1/2 X 2			
10"	12,70				3 X 1 1/2			
12"	12,70				3 X 2			
14"	12,70				3 X 2 1/2			
16"	12,70				4 X 2			
18"	12,70				4 X 2 1/2			
					4 X 3			
					5 X 2			
					5 X 2 1/2			
					5 X 3			
					5 X 4			
					6 X 2 1/2			
					6 X 3			
					6 X 4			
					6 X 5			
					8 X 4			
					8 X 5			
					8 X 6			
					10 X 4			
					10 X 5			
					10 X 6			
					10 X 8			
					12 X 6			
					12 X 8			
					12 X 10			

PROI ZVODI TEL: *RACORDERIE METALLICHE SPA*, I TALI JA
UVOZNI K: METALTERM DOO, SKOPJE, MAKEDONI JA

*цените се во денари
*го задржуваме правото на измени без обврска кон клиентите

ЦРНА РАБНА ЦЕВКА DIN 2440

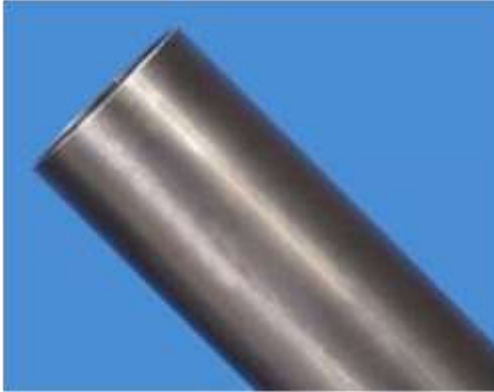

CRNA RABNA CEVKA DIN 2440			
DI MENZI JA	EDI N. MERKA	CENA БЕЗ DDV	CENA SO DDV
3/8"	MTR.		
1/2"	MTR.	80	94
3/4"	MTR.	105	124
1"	MTR.	154	182
1 1/4"	MTR.	195	230
1 1/2"	MTR.	232	274
2"	MTR.	282	333
2 1/2"	MTR.	462	545
3"	MTR.	582	687
4"	MTR.	786	927

ФИТИНГ ОД ЧЕЛИК

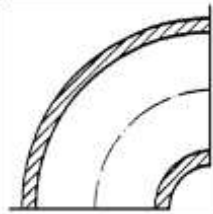
CRNO KOLENO: R = 1.5 D
STANDARD: DIN 2605
MATERI JAL: ST.37 - ^.1212
POTEKLO: I TALI JA
LEGENDA:
S - DEBELI NA NA YI DOT
D - NADVORE[EN DI JAMETAR
ND - NOMI NALEN DI JAMETAR

ND, inch	D, mm	S, mm	kg / парче	Pakuvawe	Cena/par. bez ddv	Cena / par.so ddv
1/2"	21.3	2.0	0.04	100	107	126
3/4"	26.9	2.3	0.07	100	90	106
1"	33.7	2.6	0.12	80	81	95
5/4"	38.0	2.6	0.16	80		
5/4"	42.4	2.6	0.19	50	107	126
6/4"	44.5	2.6	0.22	50		
6/4"	48.3	2.6	0.27	50	125	148
6/4"	51.0	2.6	0.33	50		
2"	57.0	2.9	0.44	25		
2"	60.3	2.9	0.49	25	203	240
2"	63.5	2.9	0.58	5		
2 1/2"	70.0	2.9	0.70	5		
2 1/2"	76.1	2.9	0.79	5	287	339
3"	88.9	3.2	1.22	5	405	478
3 1/2"	101.6	3.6	1.83	4	651	768
4"	108.0	3.6	2.08	4	686	809
4"	114.3	3.6	2.37	4	699	825
5"	133.0	4.0	3.64	3	1121	1323
5"	139.7	4.0	4.04	3	1177	1389
6"	159.0	4.5	5.90	3	1836	2167
6"	168.3	4.5	6.50	1	1875	2212
8"	219.1	6.3	14.90	1	5058	5969
10"	273.0	6.3	24.90	1	9639	11374
12"	323.9	7.1	40.00	1	14123	16665

CRN MUF
STANDARD: DIN 2605
MATERI JAL:
ST.37 - ^.1212
POTEKLO: I TALI JA

ND, inch	S, mm	Pakuvawe	Cena/par. bez ddv	Cena / par.so ddv	ЦРН МУФ НАВОЈ/ ЗАВАРУВАЊЕ ЦЕНА БЕЗ ДДВ	ЦРН МУФ НАВОЈ/ ЗАВАРУВАЊЕ ЦЕНА СО ДДВ
3/8"	2.35	150	45	53		
1/2"	2.65	150	55	65	74	87
3/4"	2.65	150	68	80	84	99
1"	3.25	10	86	102	107	126
5/4"	3.25	50	123	145	134	158
6/4"	3.25	40	142	168	151	178
2"	3.65	25	185	218	231	272
2 1/2"	3.65	1	283	334	399	471
3"	4.05	1	327	386	507	598
4"	4.50	1	665	785	718	847

*цените се во денари

*го задржуваме правото на измени без обврска кон клиентите







06.03.2026

ВЕНТИЛИ СО ПРИРАБНИЦИ ПО DIN

Цени со ДДВ

Дим.	ШИБЕР F4	ШИБЕР F5	ФИЛТЕР	РЗВ ВЕНТИЛ	ТОПЧЕСТ ВЕНТИЛ	НЕПОВРАТЕН ВЕНТИЛ SWING	НЕПОВРАТЕН ВЕНТИЛ	ЛЕПТИР ВЕНТИЛ GGG40 EPDM
	PN 10 T° - 10	PN 16	PN 16	PN 16	PN 16	PN 16	PN 16	
T° -10 +120								
15		ПО БАРАЊЕ	1532	5423	3129			
20			1837	4983	3464			
25			2405	6151	3938			
32			2844	6376	4282			
40			3445	12568	5255			
50			4405	10331	5609			
65	9172		5664	12313	6352			
80	10547		7329	18223	10174			
100	13564		10480	19240	14487			
125			18891	31028	26435			
150			21803	54269	43183			
200				57219				12763
250								
300								
								

Увозник: Металтерм ДОО, Производител: Дулар Вапа—по барање

Дим.	ШИБЕР F4	ШИБЕР F4	ФИЛТЕР	РЗВ ВЕНТИЛ	НЕПОВРАТЕН ВЕНТИЛ SWING	ТОПЧЕСТ ВЕНТИЛ
	PN 10/16	PN 10	PN 16	PN 16	PN 16	PN 16
	T° 0 +120	T° 0 +120	T° -10 +200	T° 0 +120	T° -10 +100	T° 0 +150
15				2420		3625
20				2855		4682
25				3440		5453
32				4123		6313
40	8001		2568	5385		7552
50	8624		4256	6381	5570	8885
65	10059		6298	8413	8353	14009
80	11396		7352	13222	10441	16063
100	14889		9610	17366	12763	23037
125	19563		13662	26489	19726	44848
150	26171		19110	38496	27844	57909
200		42514	33731	64887	37129	102669
250		68557	56942		62115	
300		95472	84227		89608	
350			150689			
400			261197			
500			671290			
						

Uvozni k: Metal term DOO, Proizvodi tel : Sferaco Франција, ATUSA Шпанија

*цените се во денари

*го задржуваме правото на измени без обврска кон клиентите

02.04.2025

КОНДЕНЗНИ ЛОНЧИЊА

МАТЕРИЈАЛ

ТЕЛО	ГУСЕН
КАПАК/ТАПА	ГУСЕН
НАСЕД	SS 410
ДИСК	SS 304
ЗАПТИВКА	PTFE
ФИЛТЕР	SS 304

Термодинамички тип

Притисок на испитување:	Тело 32 bar (Хидростатично)
Работен притисок:	0,3 bar – 16 bar
Температура:	220°C

КАПАЦИТЕТ (кг/час)

P BAR	0,3	0,6	1	2	3	4	5	6	8	10	12	14	16
15 – 25	183	220	253	330	345	385	420	450	510	570	630	680	740
32	350	410	490	620	730	820	900	960	1080	1200	1320	1440	1560
40	440	520	610	780	900	1000	1090	1180	1350	1500	1650	1790	1930
50	460	560	670	850	1000	1110	1220	1320	1500	1680	1860	2030	2200

ST-T3F Фланши

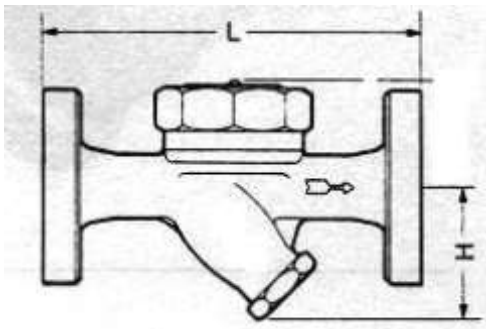

ДУ	цол	1/2	3/4	1	1 1/4	1 1/2	2
	мм	15	20	25	32	40	50
L (мм)		142	160	182	244	244	268
H (мм)		67	73	92	107	107	125

ЦЕНА БЕЗ ДДВ 3417 4851 5752 6923 9821 17212

ЦЕНА СО ДДВ 4032 5724 6787 8169 11589 20310

Димензии на фланшите – по DIN

ST-T3A Навој

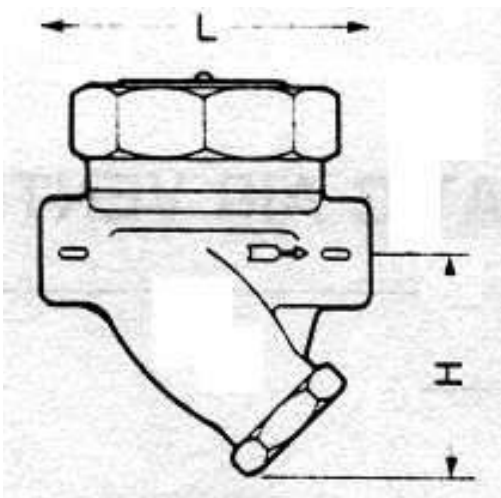

ДУ	цол	1/2	3/4	1	1 1/4	1 1/2	2
	мм	15	20	25	32	40	50
L (мм)		67	105	112	173	187	203
H (мм)		54	56	61	87	92	101

ЦЕНА БЕЗ ДДВ 3802

ЦЕНА СО ДДВ 4486

Димензии на навојот – по BS21, ANSI B2.1 или DIN 259

ПРОИЗВОДИТЕЛ: 317 LTD., ТАЈВАН
УВОЗНИК: МЕТАЛТЕРМ ДОО, СКОПЈЕ

*цените се во денари
*го задржуваме правото на измени без обврска кон клиентите

01.06.2023

НЕПОВРАТНИ КЛАПНИ

<p>Двоен диск Тело: гус Диск: гус Заптивање: EPDM PU 16, T 110°C</p>  <p>05</p>	<p>Еднодисков Тело: инокс 304/316 Диск: инокс 304/316 Заптивање: метал/ метал PU 40, T 200°C</p> 	<p>Тип Мигалка Тело: железо Диск: железо Заптивање: EPDM/NBR PU 16, T 110°C</p> 	<p>Тип Мигалка Тело: 316/316L Диск: 316/316L Заптивање: FKM PU 16, T 180°C</p> 
--	--	---	--

ДИМЕНЗИЈА ДН	ЦЕНА СО ДДВ	ЦЕНА СО ДДВ	ЦЕНА СО ДДВ	ЦЕНА СО ДДВ
15		1402		
20		1783		
25		2261		
32		3005		
40		3774	2556	
50	2922	5455	2618	
65	3165	8570	2866	
80	3895	12028	3430	
100	4869	14430	4511	
125	6086	По барање димензии ДН125—ДН600	6281	
150	8521		7781	
200	13878		12453	
250	19476		19147	
300	28449		31744	
350				
400				
450				
500				

ЧЕЛИЧНИ ФЛАНШИ ПО DIN



DI - MENZI JA	DIN 2633/PN 16 SO GRLO		DIN 2635/PN 40 SO GRLO		DIN 2527/PN10 SLEPA		DIN 2566/PN16 SO NAVOJ		DIN 2576/PN 10 RAMNA		DIN 2576/PN 16 RAMNA	
	без ДДВ	со ДДВ	без ДДВ	со ДДВ	без ДДВ	со ДДВ	без ДДВ	со ДДВ	без ДДВ	со ДДВ	без ДДВ	со ДДВ
1/2"	450	531	508	600	278	328	492	580	232	274	413	487
3/4"	551	650	714	843	469	553	657	775	256	302	440	519
1"	597	705	776	916	511	603	702	828	320	378	470	555
1 1/4"	814	961	1026	1211	695	820	915	1080	555	655	771	910
1 1/2"	853	1007	1205	1422	789	931	1305	1540	622	734	881	1040
2"	1047	1236	1428	1685	832	982	1322	1560	781	922	1150	1357
2 1/2"	1249	1474	1874	2211	1089	1285	1488	1756	1001	1181	1484	1751
3"	1551	1830	2409	2843	1338	1579	1857	2191	1236	1458	1517	1790
4"	1799	2123	3301	3895	1661	1960	2842	3354	1322	1560	1850	2183
5"	2528	2983	5085	6000	2471	2916			1932	2280	2175	2567
6"	3211	3789	6691	7895	3068	3620			2060	2431	2889	3409
8"	4452	5253	13738	16211	4859	5734			2771	3270	4028	4753
10"	9306	10981			7640	9015			4499	5309	5723	6753
12"					9671	11412			5105	6024	7964	9398

ELEMENTI ZA SPOJUVAWE NA PRI RABNI CI

ZAPTI VEN ELEMENT - DIHTUNG OD KLINGERT

RABOTNA TEMPERATURA: DO 300°C

DEBELI NA: 2 - 4 mm VO ZAVI SNOST OD NO

DI MENZI I SOGLASNO DIN 2690

OD NO 15 DO NO 300



DI MENZI JA	CENA/PAR^E BEZ DDV	CENA/PAR^E SO DDV
15	25	30
20	36	42
25	42	50
32	60	71
40	62	73
50	85	100
65	121	143
80	140	165
100	182	215
125	364	429
150	452	533
200	558	658
250	893	1054
300	1394	1645

MA[I NSKI ZAVRTKI I NAVRTKI

KVALITET: 5.6 DO NP 16, CRNI I I CI NKANI

ZAVRTKI		
DI MENZI - JA	CENA/PAR^E BEZ DDV	CENA/PAR^E SO DDV
M 12 / 40	20	24
M 12 / 50	22	26
M 12 / 60	26	31
M 16 / 60	43	51
M 16 / 70	53	62

NAVRTKI		
DI MENZI - JA	CENA/PAR^E BEZ DDV	CENA/PAR^E SO DDV
M 12	7	8
M 16	12	14
M 20	19	23

LEGENDA: **L** - AKTI VNA DOL@I NA NA ZAVRTKATA

M - NAVOJ

n - BROJ NA DUPKI

NO	NP 6			NP 10			NP 16			NP 25/40		
	L	M	n	L	M	n	L	M	n	L	M	n
15	40	10	4	45	12	4	45	12	4	50	12	4
20	45	10	4	50	12	4	50	12	4	50	12	4
25	45	10	4	50	12	4	50	12	4	50	12	4
32	45	12	4	50	16	4	50	16	4	55	16	4
40	45	12	4	50	16	4	50	16	4	55	16	4
50	45	12	4	55	16	4	55	16	4	60	16	4
65	45	12	4	55	16	4	55	16	4	65	16	8
80	60	16	4	60	16	4	60	16	8	70	16	8
100	60	16	8	60	16	8	60	16	8	70	20	8
125	60	16	8	65	16	8	65	16	8	80	24	8
150	60	16	8	65	20	8	65	20	8	90	24	8

*цените се во денари

*го задржуваме правото на измени без обврска кон клиентите

ДИЛАТАЦИОНИ КОМПЕНЗАТОРИ

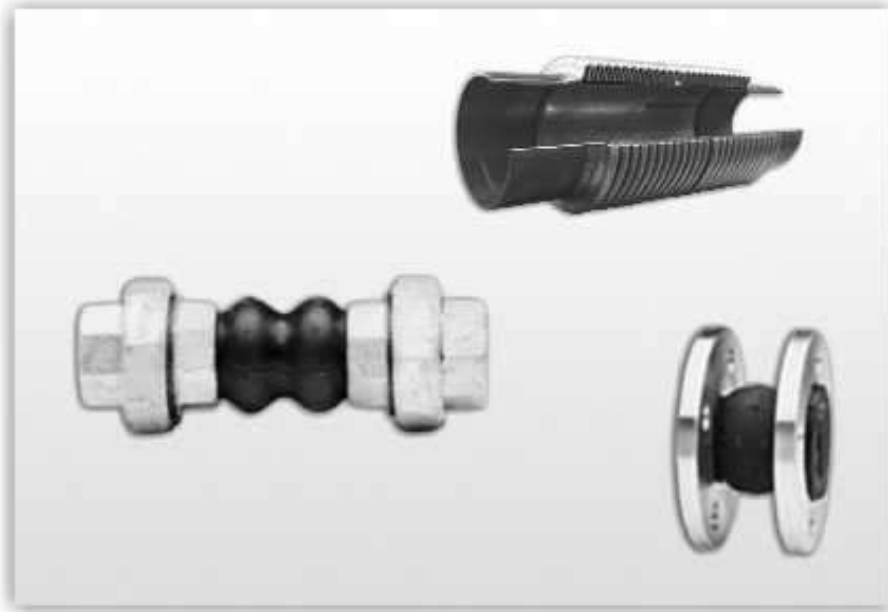

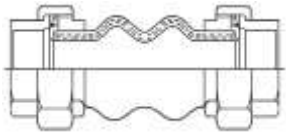
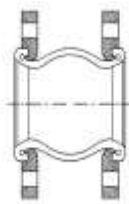
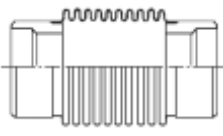
ДИ МЕНЗИ ЈА	GUMEN KOMPENZATOR SO HOLENDERI		GUMEN KOMPENZATOR SO PRI RABNI CI				KOMPENZATOR SO ZAVARUVAVE	
	без ДДВ	со ДДВ	PN10		PN16		без ДДВ	со ДДВ
	без ДДВ	со ДДВ	без ДДВ	со ДДВ	без ДДВ	со ДДВ	без ДДВ	со ДДВ
1/2"	1811	2137						
3/4"	1811	2137						
1"	1853	2187					7440	8779
1 1/4"	1920	2266	2615	3086			8040	9487
1 1/2"	2078	2452	2661	3140			8330	9829
2"	2721	3211	2762	3259			8704	10271
2 1/2"	3971	4686	3412	4026			12726	15017
3"	5030	5935	3778	4458			14277	16847
4"			4626	5459			16460	19423
5"			6839	8070			19258	22724
6"			8224	9704			22984	27121
8"			13195	15570	14128	16671	30015	35418
10"			19524	23038	19914	23499	38100	44958
12"			35503	41894	24337	28718		
14"			23740	28013				
16"			44722	52772				
								

El ektro - magneten venti | **TORK**



Proizvodi tel : **Tork**, Turci ja
Uvozni k: Metal term

Namena:
Voda, vazduh, i nertni gasovi (azot, argon i dr.)

Temperatura:
-10...+80°C

Napon:
12 V AC/DC...220 V AC

Tip		Pri kl u-ok	Светло сечение	KV	Pri ti sok		Cena, Denari /par	
					mm	lt/min	min bar	max bar
T-GM 102	H3	3/8"	12	40	0,5	16		
T-GM 102A	HO			40	0,5	16		
T-GM 103	H3	1/2"	14	45	0,5	16	3424	4040
T-GM 103A	HO			45	0,5	16	4449	5250
T-GM 104	H3	3/4"	17	80	0,5	16	3780	4460
T-GM 104A	HO			80	0,5	16	4805	5670
T-GM 105	H3	1"	17	80	0,5	16	4237	5000
T-GM 105A	HO			80	0,5	16	4915	5800
T-GM 109	H3	1 1/4"	40	400	0,5	10	10466	12350
T-GM 109A	HO			400	0,5	10	11525	13600
T-GM 106	H3	1 1/2"	40	400	0,5	10	10720	12650
T-GM 106A	HO			400	0,5	10	11864	14000
T-GM 107	H3	2"	50	540	0,5	10	12881	15200
T-GM 107A	HO			540	0,5	10	14322	16900
T-GM 102 N	H3	3/8"	12	40	0,5	16		
T-GM 103 N	H3	1/2"	14	45	0,5	16		

bez i ndeks (T-GM 102) - H3 normal no zatvoren
i ndeks "A" (T-GM 102A) - HO normal no otvoren
i ndeks "N" (T-GM 102N) - za naf ta

Po nara-ka se i spora-uvaat: $t_{max} = 160^{\circ}C$, $P_{min} = 0$ bar, $P_{max} = 40$ bar, 3" и др.

Спојки и фитинзи Quikcoup







 Proizvodi tel : *Modgal, Израел* Uvozni k: Metal term DOO

Ознака		Цени со ддв													
		1"	1	1 1/2"	2"	2 1/2"	3"	108	4"	133	5"	159	165	6"	8"
	Флексибилна спојка Flexible coupling ST 75														
	Спојка Rigid coupling ST 75RT		209	237	242	304	344		391		804			982	1388
	Флексибилна спојка Quikhinge ST 007														
	Спојка Quikhinge ST 007RT														
	Колено 90° Quikbend ST 06		183	220	267	475	646		659		1722			1841	2611
	Колено 45° Quikbend ST 04				409	535	895		1062		1123			1805	2524
	Тештик Tee ST 05			304	575	774	616		988		2181			2205	2609
	Фланша Quikflange ST 91				839	839			1435					1435	
	Колено 90° Краток радиус Quikbend ST 66	174	206	220	267	475	646		659		1722			1841	2611
	Тештик Краток радиус Tee ST 65		253	304	575	777	839		988		2181			2205	4104
	Капа End-cap ST 02			76	142	309	326		351		631			2200	

*цените се во денари

*го задржуваме правото на измени без обврска кон клиентите

01.02.2024

Ознака		1"	1 1/4"	1 1/2"	2"	2 1/2"	3"	108	4"	133	5"	159	165	6"	8"
Редуцир спојка ST 71 	1 1/2"														
	2"														
	2 1/2"														
	3"														
	4"														
	5"														
	6"														
Навој Ж Quik-T ST 08T 	3/4"														
	1"														
	1 1/4"														
	1 1/2"														
	2"	392		392											
	2 1/2"		544	351	544										
	3"	649	686	719	755										
4"		590	486	680	1199										
5"		696	696	755											
6"		1715	1037				1401		2760						
Разклонител- Т Со канал Quik-T ST 08G 	1 1/4"														
	1 1/2"														
	2"		626	806											
	2 1/2"		1006	1054											
	3"		1050	546	791										
	4"		1008	1014	1028	1070	1306								
5"				1573	1596										
6"				1076	1093	1212			1232						
	3/4"														
	1"														
	1 1/4"	266													
	1 1/2"	281													
	2"	293													
	2 1/2"	387													
	3"														
4"															
Разклонител Quiklet ST 99	1/2"														
	3/4"														
	1"														
Редуцир ST 15 	1 1/4"														
	1 1/2"														
	2"														
	2 1/2"			114											
	3"														
	4"														
Т - редуцир ST 55 	5"														
	1"														
	1 1/2"														
	2"														
	2 1/2"														
	3"														
4"					3082										
5"															
6"															

*цените се во денари

*го задржуваме правото на измени без обврска кон клиентите

01.02.2024

АРМАТУРА И ДОДАТОЦИ ЗА ПРОТИВОПОЖАРНИ ИНСТАЛАЦИИ

КСК вода-вода	DN80	DN100	DN150	DN200
КСК на фланши (или жлеб) DN80-200 слика 1 моторен вентил со мониторинг/аларм Технички вентил пресостат EPS10 Сензор на проток Алармно свонче				
моторен вентил со мониторинг/аларм слика.2				
моторен вентил со мониторинг/аларм слика.2 на жлеб				
пресостат EPS10 слика.3				
Алармно свонче ACS VM 325500 слика 4				
Сензор на проток слика.5				



сл. 2



сл. 3



сл. 4



сл. 5



сл. 1



КСК вода-воздух	DN80	DN100	DN150
КСК на фланши (или канал) DN80-150 слика 1 пресостат за воздух-вода слика 3 моторен вентил со мониторинг/аларм слика 2 на жлеб акцелератор за воздух слика 5			
Аларно свонче ACS VM 325500 слика 4			
Уред за одржување на притисокот слика 6			



сл. 3



сл. 2



сл. 5



сл. 4



сл. 6



сл. 1

Пожарна кутија комплет Кутија црвена 500/500-140 RAL 3000 цедро 20м 16bar млазница 13mm Кос вентил 2" с о спојка	
---	--

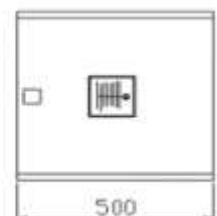

МАШИНА ЗА ПРАВЕЊЕ ЖЛЕБОВИ YG12E

Мала 1 1/4" ÷ 6"

Голема 1" ÷ 12"



СПРИНКЛЕРИ

Цени в лв/бр, без ДДС

- димензија на отворот: 1/2"; 17/32"
- фактор : K80 (5.6); K115 (8)
- Големина на приклучок: 1/2" NPT; 3/4"
- макс.работен притисок: 12bar (175psi)
- мин.работен притисок: 0.5bar (7psi)
- Тест притисок 34bar (500psi)

Боја на ампулата	Темп.
портакалов	57°C
црвен	68°C
Жолт	79°C
зелен	93°C
син	141°C
портакалов	57°C
црвен	68°C
жолт	79°C
зелен	93°C

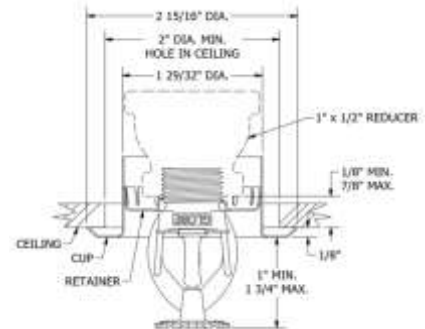

Тип спринклер	Реакција	K=80 (5,6)		K=115 (8)	
		1/2"		3/4"	
		Шифра на производ		Шифра на производ	
Сточечки Месинг	STANDARD	566113501		816413501	
		566115501		816415501	
		566117501		816417501	
		566120001		816420001	
		566128601		816428601	
Висечки Месинг	STANDARD	565113501		815613501	
		565115501		815615501	
		565117501		815617501	
		565120001		815620001	

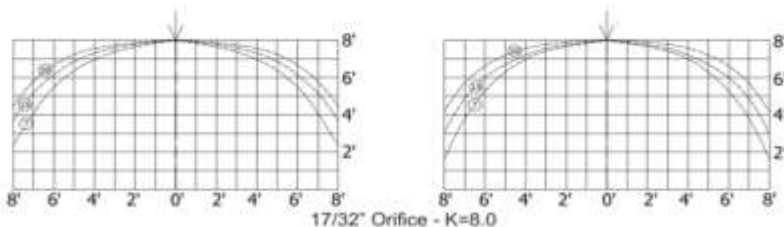
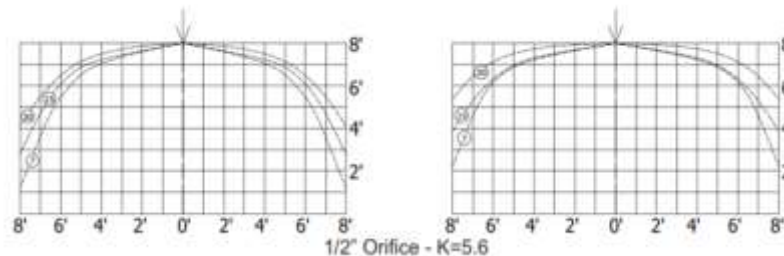

1 ft = 0,3048

ЦЕВКИ		МАСТ	
	Рабни цевки, хидроиспитани, прашково бојадисани во црвена боја за противопожарни инсталации, RAL 3000, EN 10255 1"- 8"-		Маст за фитинзи за противопожарни инсталации 0,91 кг/кутија

НАЗИВ	ДИМЕНЗИЈА	ЦЕНА СО ДДВ/МЕТРО
Сплинкер цевка црвена 1"(33.7x2.77)	1"(33.7x2.77)	415
Сплинкер цевка црвена 1"(33.7x3.2)	1"(33.7x3.2)	476
Сплинкер цевка црвена 1"(33.7x3.2) без жлеб	1"(33.7x3.2) без жлеб	476
Сплинкер цевка црвена 1 1/4"(42.4x2,77)	1 1/4"(42.4x2,77)	534
Сплинкер цевка црвена 1 1/4"(42.4x2,9)	1 1/4"(42.4x2,9)	563
Сплинкер цевка црвена 1 1/4"(42.4x3,2)	1 1/4"(42.4x3,2)	611
Сплинкер цевка црвена 1 1/2"(48.3x2,77)	1 1/2"(48.3x2,77)	632
Сплинкер цевка црвена 1 1/2"(48.3x2,9)	1 1/2"(48.3x2,9)	648
Сплинкер цевка црвена 1 1/2"(48.3x3,2)	1 1/2"(48.3x3,2)	703
Сплинкер цевка црвена 2"(60.3x2,77)	2"(60.3x2,77)	771
Сплинкер цевка црвена 2"(60.3x2,9)	2"(60.3x2,9)	818
Сплинкер цевка црвена 2"(60.3x3,6)	2"(60.3x3,6)	927
Сплинкер цевка црвена 2 1/2"(76.1x2,77)	2 1/2"(76.1x2,77)	1010
Сплинкер цевка црвена 2 1/2"(76.1x2,9)	2 1/2"(76.1x2,9)	1045
Сплинкер цевка црвена 2 1/2"(76.1x3,6)	2 1/2"(76.1x3,6)	1273
Сплинкер цевка црвена 2 1/2"(76.1x3,2)	2 1/2"(76.1x3,2)	1090
Сплинкер цевка црвена 3"(88.9x3,05)	3"(88.9x3,05)	1188
Сплинкер цевка црвена 3"(88.9x3,2)	3"(88.9x3,2)	1227
Сплинкер цевка црвена 3"(88.9x4)	3"(88.9x4)	1535
Сплинкер цевка црвена 4"(114.3x3,05)	4"(114.3x3,05)	1634
Сплинкер цевка црвена 4"(114.3x3,2)	4"(114.3x3,2)	1729

